 The-Safety-Valve.com	<b>Sizing acc. to          API 520 for Gas          VALVESTAR® - v.7.2.3.1205</b>	Page:	1 of 7
		Date:	2014-05-19 14:10:08
		Project:	New project
		Tag No:	LESER Job N°

Sizing - Medium			
1000	Designation	Methane	
1004	Formula	CH4	
1001	Molar mass	M	16 kg/kmol
1002	Ratio of specific heats	k	1,310
1003	Compressibility factor	Z	1,000

Sizing - Service condition			
1100	Maximum allowable working pressure		
1101	Set pressure	p	100 bar-g
1102	Superimposed back pressure	paf	0 psi-g
1103	Built up back pressure	pae	
1104	Backpressure		0 psi-g
1105	Overpressure	dp	10,00 %
1106	Environmental pressure	pu	14,696 psi
1107	Temperature	T	15 °C
1108	Required massflow	qm,ab	2.000 kg/h
1109	Volume flow to be discharged (working condition)	qvb,ab	952,653 ft <sup>3</sup> /h
1110	Volume flow to be discharged (std condition) [T=60 °F P=14,7 psi]	qvn,ab	1.742,212 SCFM
1120	Rupture disc correction factor	Kc	1,000

Sizing - Calculation			
1200	Certified massflow	qm,zu	5.485,659 lb/h
1201	Certified volume flow (operating condition)	qvb,zu	1.185,221 ft <sup>3</sup> /h
1203	Certified volume flow (standard condition)	qvn,zu	3.683,148 m <sup>3</sup> /h
1204	Maximum mass flow	qm,max	6.095,177 lb/h
1205	Maximum volume flow (working condition)	qvb,max	1.316,912 ft <sup>3</sup> /h
1206	Maximum volume flow (standard condition)	qvn,max	4.092,387 m <sup>3</sup> /h
1207	Capacity exceed		24,41 %

Name	EUREA			
Date	2014-05-19 14:10:09			
Rev.No	1			

 The-Safety-Valve.com	<b>Sizing acc. to          API 520 for Gas          VALVESTAR® - v.7.2.3.1205</b>	Page:	2 of 7
		Date:	2014-05-19 14:10:08
		Project:	New project
		Tag No:	
		LESER Job Nº	

Valve - General			
1500	Article number		4374.3154
1512	Reseller article number		
1513	Quantity of safety valve		1
1501	Certified coefficient of discharge for steam and gases	K,DG	0,458
1502	Certified coefficient of discharge for liquid	K,F	0,333
1453	Orifice		0,52xD
1505	Bonnet / Lifting device		Lifting device H4 (gastight)
1506	Body-/ Inlet base material		1.4404 / 316L
1511	Bonnet		Closed Bonnet
1514	Order code	4374.3154-100 bar_g-V54V65-3.1	

Inlet connection		
1307	Thread standard	G - Male thread acc. to DIN ISO 228-1
1308	DN	G 1/2"

Outlet connection		
1357	Thread standard	G - Female thread acc. to DIN ISO 228-1
1358	DN	G 1/2"

Valve - Dimensions				
1400	Discharge area	Ao	0,122	in <sup>2</sup>
1401	Discharge diameter	do	0,394	inch
1402	Centre to Face dimensions	a	1,299	inch
1403	Centre to Face dimensions	b	1,181	inch
1405	Height	H	9,134	inch
1406	Weight	M	3,086	lb
1413	Thread length	C	0,551	inch

Lift				
1507	Standard		0,055	inch

Name	EUREA			
Date	2014-05-19 14:10:09			
Rev.No	1			

 The-Safety-Valve.com	<b>Sizing acc. to          API 520 for Gas          VALVESTAR® - v.7.2.3.1205</b>	Page:	3 of 7
		Date:	2014-05-19 14:10:08
		Project:	New project
		Tag No:	LESER Job N°

Valve - Calculation				
1200	Certified massflow	qm,zu	5.485,659	lb/h
1201	Certified volume flow (operating condition)	qvb,zu	1.185,221	ft <sup>3</sup> /h
1203	Certified volume flow (standard condition)	qvn,zu	3.683,148	m <sup>3</sup> /h
1204	Maximum mass flow	qm,max	6.095,177	lb/h
1205	Maximum volume flow (working condition)	qvb,max	1.316,912	ft <sup>3</sup> /h
1206	Maximum volume flow (standard condition)	qvn,max	4.092,387	m <sup>3</sup> /h
1207	Capacity exceed		24,41	%
1600	Required actual discharge area	Ao, req	0,098	in <sup>2</sup>
1601	Required discharge diameter	do,req	0,353	inch
1611	Reaction force (acc. to API 520)	Fr	71,176	lbf
1617	Back pressure correction factor	Kb	1,000	
1618	Cold differential test pressure	CDTP	1.450,377	psi-g
1620	Cold differential test pressure, manually	CDTP		

Name	EUREA			
Date	2014-05-19 14:10:09			
Rev.No	1			

 The-Safety-Valve.com	<b>Sizing acc. to          API 520 for Gas          VALVESTAR® - v.7.2.3.1205</b>	Page:	4 of 7
		Date:	2014-05-19 14:10:08
		Project:	New project
		Tag No:	
		LESER Job N°	

Valve - Part list					
	PosNo	Denomination	Q	Material ASME	Material DIN
12010	1	Inlet body	1	316L	1.4404
12020	2	Outlet body	1	316L	1.4404
12070	7	Disc incl. detachable lifting aid	1	316L	1.4404
12120	12	Spindle	1	316L	1.4404
12160	16	Spring plate	1	316L	1.4404
12170	17	Spring plate	1	316L	1.4404
12180	18	Adjusting screw	1	316L	1.4404
12190	19	Lock nut	1	316L	1.4404
12540	54	Spring	1	Stainless steel	1.4310
12570	57	Pin	1	Stainless steel	1.4310
12610	61	Ball washer	1	Hardened Stainless steel/316	1.3541/1.4401

LESER is free to upgrade materials without further notice.

Name	EUREA				
Date	2014-05-19 14:10:09				
Rev.No	1				

**Drawing**

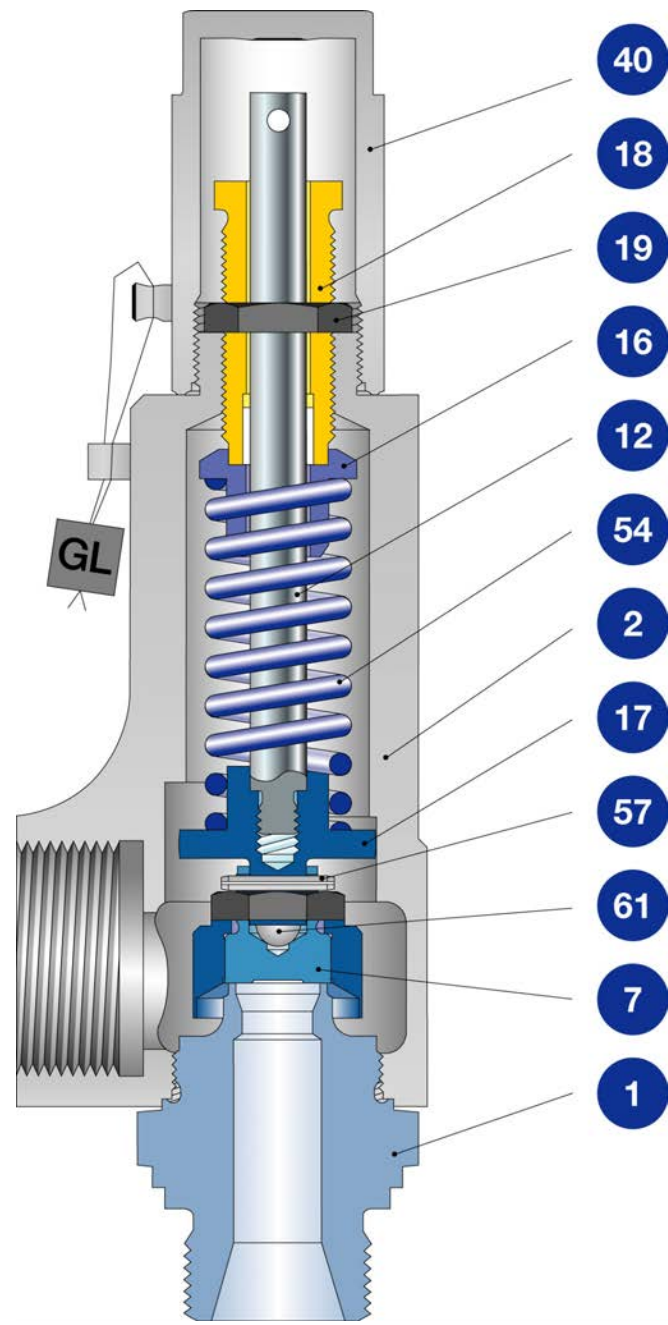

Drawing is a view; the effective geometry could deviate from this view.

Name	EUREA				
Date	2014-05-19 14:10:09				
Rev.No	1				

<b>LESER</b> The-Safety-Valve.com	<b>Sizing acc. to          API 520 for Gas          VALVESTAR® - v.7.2.3.1205</b>	Page:	6 of 7
		Date:	2014-05-19 14:10:08
		Project:	New project
		Tag No:	
		LESER Job N°	

**Drawing**

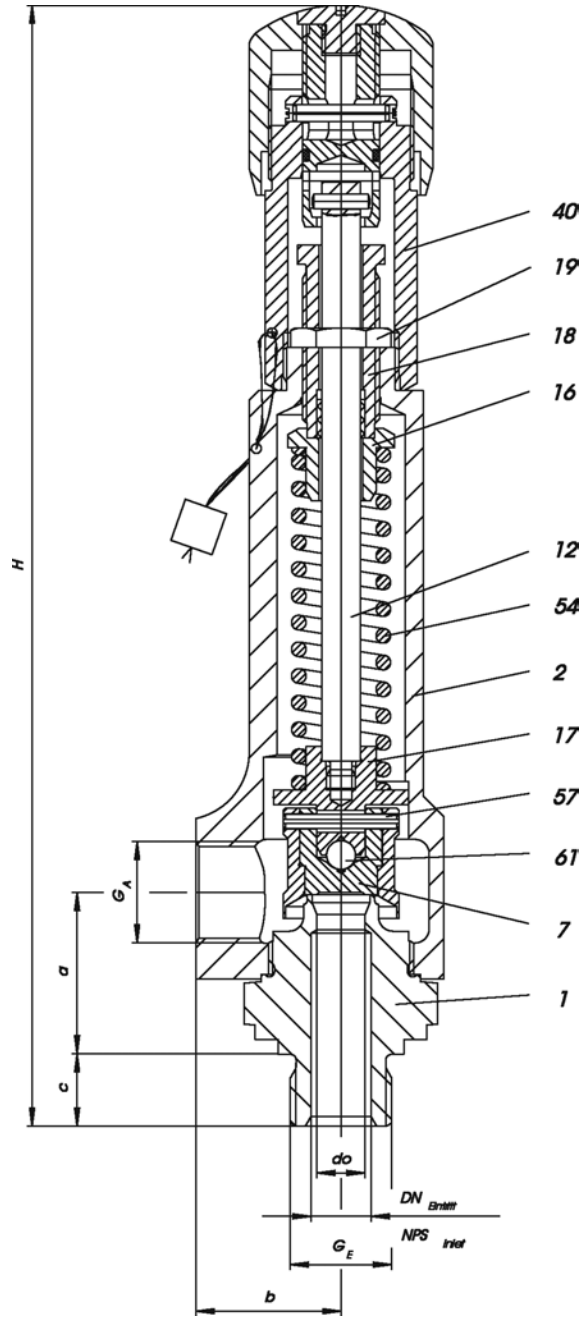



Drawing is a view; the effective geometry could deviate from this view.

Name	EUREA			
Date	2014-05-19 14:10:09			
Rev.No	1			

 The-Safety-Valve.com	<b>Sizing acc. to API 520 for Gas VALVESTAR® - v.7.2.3.1205</b>	Page:	7 of 7
		Date:	2014-05-19 14:10:08
		Project:	New project
		Tag No:	
		LESER Job No	

**ASME nameplate**

**TYPE 4374.3154**  
 NPS G 1/2" XG 1692 SCFM  
 CDTP 1.450,377 set-p 1.450,3 psig  
 back-p 0 psig

  
 0045

**DIN nameplate**

 4374.3154

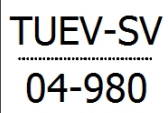
 TUEV-SV  
 04-980

D0 10,0 D/G 0,458 F 0,33



 1.450,377  
 0045

**World nameplate**

 Tag

Type	4374.3154	Size	G 1/2"	Serial no.	
Flow area	79	mm <sup>2</sup>	d <sub>0</sub> 10,0	mm	Seat
	Set p.	Back p.	CDTP	Temp.	
bar	100	0	100	15,00 °C	
psig	1.450,377	0	1.450,377	59,00 °F	
TÜV-SV	Lift 1,40	mm ISO 4126-1	ASME-Cap.		
04-980	Steam	0,46	4631	lbs/hr	
Date	Gas	0,46	1692	SCFM	
	Liquid	0,33	62	GPM	

 4374.3154-100 bar\_g-V54V65-3.1

 0045  
 cc2408  

Name	EUREA			
Date	2014-05-19 14:10:09			
Rev.No	1			